

BIFOLD DOORS FRONT ELEVATION AND CORNER DETAIL

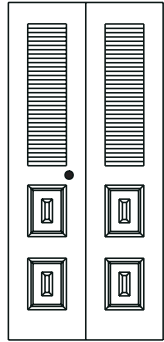

WESTCHESTER

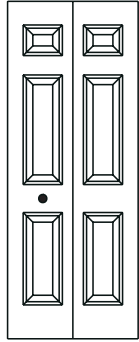

LENEX

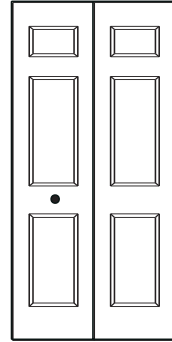

REGENCY

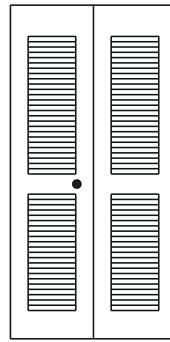

LOUVER II

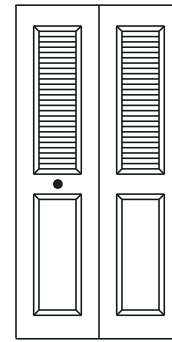

CLASSIC

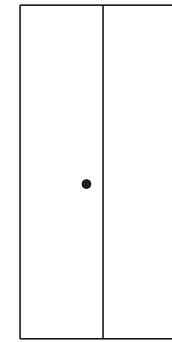

FLUSH

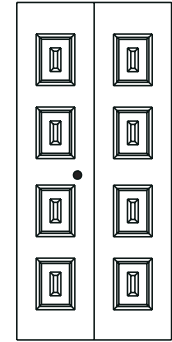

LANCASTER

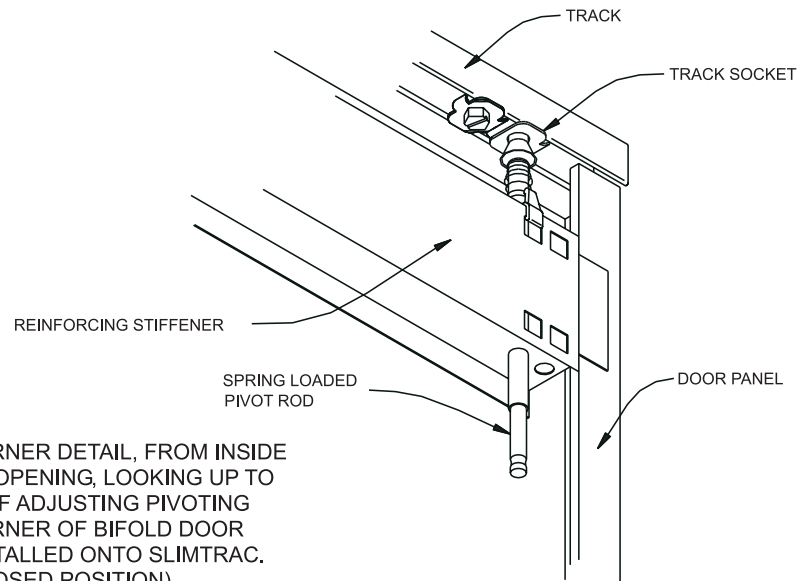

CORNER DETAIL, FROM INSIDE
OF OPENING, LOOKING UP TO
SELF ADJUSTING PIVOTING
CORNER OF BIFOLD DOOR
INSTALLED ONTO SLIMTRAC.
(CLOSED POSITION)