

# INSTALLATION SHEET

Keep These Instructions!

PLEASE FOLLOW ALL INSTRUCTIONS AND ALWAYS USE PROTECTIVE EYEWEAR WHEN INSTALLING A DOOR SYSTEM. PLEASE READ INSTRUCTIONS COMPLETELY.

## 2-or 4-PANEL BIFOLD

All Steel Bifold Door Systems

Mirror Bifold Door Systems: 2700ST, 2725ST, 2750ST, 2775ST, 2800AL, 2900AL

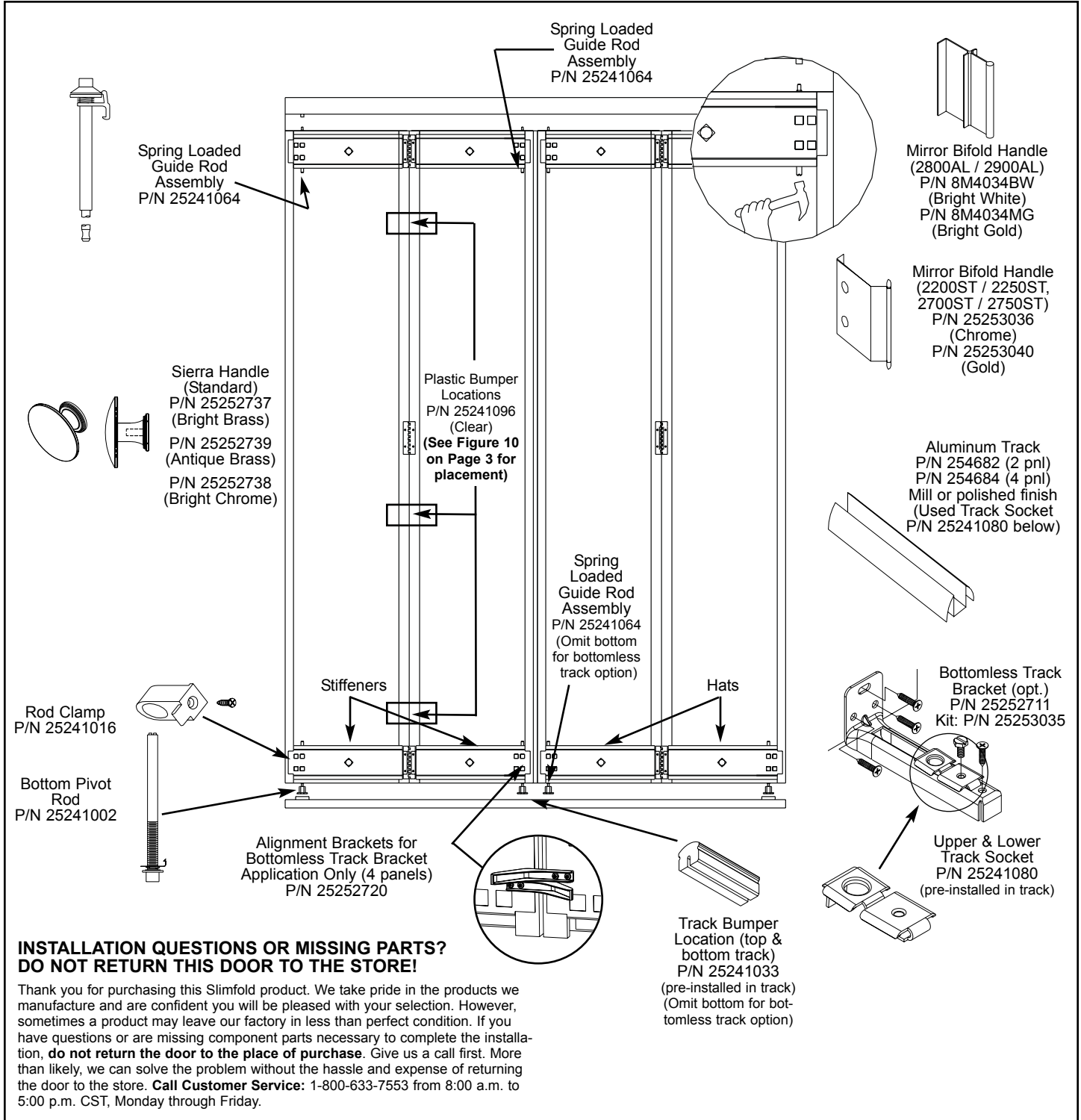

### INSTALLATION QUESTIONS OR MISSING PARTS? DO NOT RETURN THIS DOOR TO THE STORE!

Thank you for purchasing this Slimfold product. We take pride in the products we manufacture and are confident you will be pleased with your selection. However, sometimes a product may leave our factory in less than perfect condition. If you have questions or are missing component parts necessary to complete the installation, **do not return the door to the place of purchase.** Give us a call first. More than likely, we can solve the problem without the hassle and expense of returning the door to the store. **Call Customer Service:** 1-800-633-7553 from 8:00 a.m. to 5:00 p.m. CST, Monday through Friday.

# Slimfold®

Slimfold Products, A Division of the Dunbarton Corporation  
 868 Murray Road, Dothan, AL 36303  
 Toll Free: (800) 633-7553 Tel: (334) 794-0661 Fax: (334) 793-7022  
 Web Page: [www.slimfold-doors.com](http://www.slimfold-doors.com) E-mail: [slimfold@dunbarton.com](mailto:slimfold@dunbarton.com)

# BEFORE YOU BEGIN

PLEASE FOLLOW ALL INSTRUCTIONS AND ALWAYS USE PROTECTIVE EYEWEAR WHEN INSTALLING A DOOR SYSTEM. PLEASE READ INSTRUCTIONS COMPLETELY.

## Assemble Tools

- Safety glasses
- Phillips head screwdriver
- Straight head screwdriver
- Level
- Tape Measure
- Power drill or screw gun (3/16" bit)

## Measure Opening

Measure the Finished Opening Size; refer to Specifications below to insure proper door size.

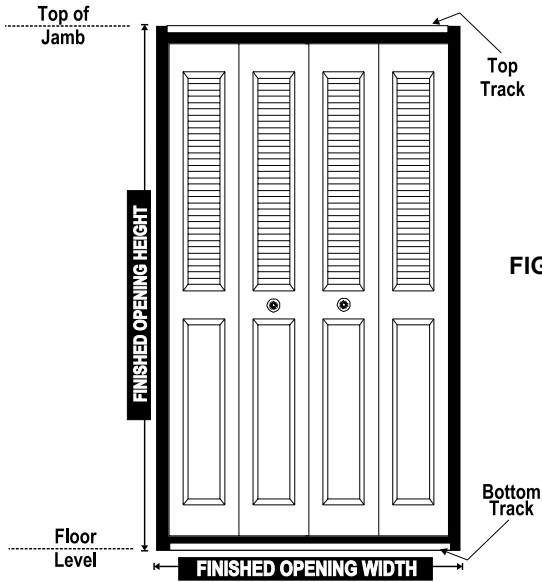

FIGURE 1

### Specifications STANDARD SIZES—TWO PANEL UNITS

| Size          | Door Width      | FINISHED OPENING WIDTH | FINISHED OPNG. HEIGHTS |                   |                   |
|---------------|-----------------|------------------------|------------------------|-------------------|-------------------|
|               |                 |                        | 6'8" Units             | 7'6" Units        | 8" Units          |
| 1'6"<br>(457) | 171/2"<br>(445) | 18"<br>(457)           |                        |                   |                   |
| 1'9"<br>(533) | 201/2"<br>(521) | 21"<br>(533)           |                        |                   |                   |
| 2'0"<br>(610) | 231/2"<br>(597) | 24"<br>(610)           | 801/2"<br>(2045)       | 90"<br>(2286)     | 96"<br>(2438)     |
| 2'3"<br>(686) | 261/2"<br>(673) | 27"<br>(686)           | +/-1/4"<br>(+/-6)      | +/-1/4"<br>(+/-6) | +/-1/4"<br>(+/-6) |
| 2'6"<br>(762) | 291/2"<br>(749) | 30"<br>(762)           |                        |                   |                   |
| 2'9"<br>(838) | 321/2"<br>(826) | 33"<br>(838)           |                        |                   |                   |
| 3'0"<br>(914) | 351/2"<br>(902) | 36"<br>(914)           |                        |                   |                   |

### STANDARD SIZES—FOUR PANEL UNITS

| Size           | Door Width    | FINISHED OPENING WIDTH | FINISHED OPNG. HEIGHTS |                   |                   |
|----------------|---------------|------------------------|------------------------|-------------------|-------------------|
|                |               |                        | 6'8" Units             | 7'6" Units        | 8" Units          |
| 3'0"<br>(914)  | 35"<br>(889)  | 36"<br>(914)           |                        |                   |                   |
| 3'6"<br>(1067) | 41"<br>(1041) | 42"<br>(1067)          |                        |                   |                   |
| 4'0"<br>(1219) | 47"<br>(1194) | 48"<br>(1219)          | 801/2"<br>(2045)       | 90"<br>(2286)     | 96"<br>(2438)     |
| 4'6"<br>(1372) | 53"<br>(1346) | 54"<br>(1372)          | +/-1/4"<br>(+/-6)      | +/-1/4"<br>(+/-6) | +/-1/4"<br>(+/-6) |
| 5'0"<br>(1524) | 59"<br>(1499) | 60"<br>(1524)          |                        |                   |                   |
| 5'6"<br>(1676) | 65"<br>(1651) | 66"<br>(1676)          |                        |                   |                   |
| 6'0"<br>(1829) | 71"<br>(1803) | 72"<br>(1829)          |                        |                   |                   |

All increments shown in (parenthesis) are metric (millimeter) unless otherwise indicated. Non-standard sizes available; check with your dealer for sizes and availability.

# INSTALLATION

## 1. Remove Door from Packing Material

Carefully open the door package and remove the track packed inside the door (track can be packed separately if requested). Locate hardware bag(s) containing the following components for **four-panel doors**:

### STEEL & MIRROR BIFOLDS (4-PANEL):

- Four #10 x 1-1/4" pan screws
- Four #10 x 3/4" screws
- Round self adhesive plastic bumpers
- Steel Bifold Handles:
  - **Classic, Louver II, Flush, Westchester, Lancaster:** Two Hawthorne handles with two 1/4" screws (one handle for 2-panel)
  - **Roanoke:** Four Roanoke handles with four long-barrel screws with nuts (two handles for 2-panel)
  - **2700ST MIRRORS:** Two bifold handles with four #10-24x1 pan head screws, four locknuts and four cup washers (one handle for 2-panel)
  - **2800AL & 2900AL MIRRORS:** Two bifold handles with handle tape (one handle for 2-panel)

## 2. Set The Tracks

**Full Tracks (Figure 2):** Center upper track on header (Figure 4). Secure track to header, using three #10 x 1-1/4" pan head

### Bottom Track Options

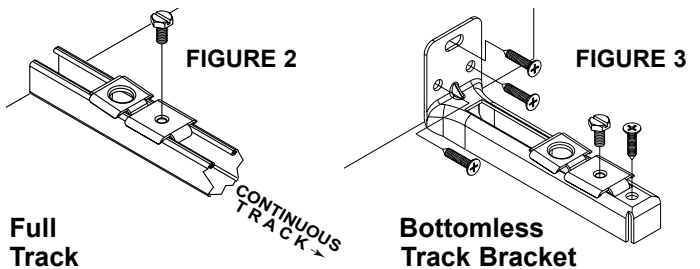

Full Track

Bottomless Track Bracket

screws (Figure 4). Set lower track directly below top track and attach to floor using #10 x 3/4" screws or concrete nails (Figures 2, 4). For a flush fit, set front of top and bottom track 5/8" in from the jamb face.

**Bottomless track (Optional; Figure 3):** Set upper track on header (Figure 4). Set bottomless track bracket on floor directly below top track. Fasten bottomless track bracket to wall using three #10 x 1-1/4" pan head screws (Figure 3). Secure to floor using #10 x 1-1/4" pan head screw (Figures 3, 4).

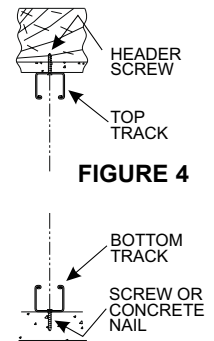

FIGURE 4

**New Construction:** For best results and performance, it is recommended that the track be put down before laying carpet. Depending upon the height of the finished floor, a continuous wood shim can be placed underneath the track to provide additional clearance between the door and carpet. The carpet can be installed up to the track and the door can be installed later.

**Existing Dwelling:** When installing SLIMFOLD doors in an area where carpet has been previously laid, lay the track on top of the existing carpet and screw into the floor below. **CAUTION: Turn screw slowly to avoid causing a runner in the carpet.**

### 3. Prepare Doors for Installation

Position doors face down on surface that will not mar finish, with bottom of doors (containing threaded pivot rods) closest to you.

Located the threaded pivot rod at the lower jamb corner of one door (Figure 5). Loosen the rod clamp screw and screw pivot rod until nylon bushing is about 1/4" below bottom of door. Prepare second panel set the same way.

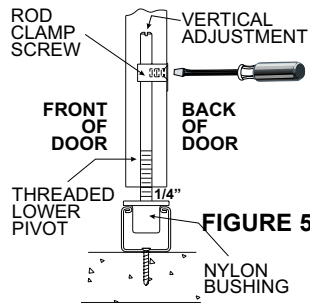

### 4. Install Doors in Opening

Lift one panel set into opening and insert lower threaded pivot into bottom track socket (Figure 6).

Center upper pivot under track socket and tap rod to release (Figure 7). Center lower and upper guides on track groove and tap rod to release. Repeat for second panel.

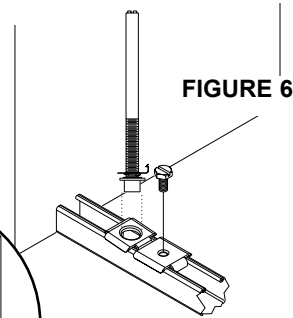
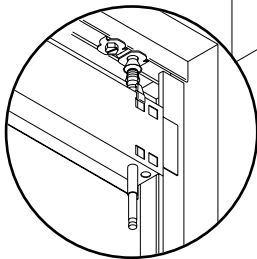
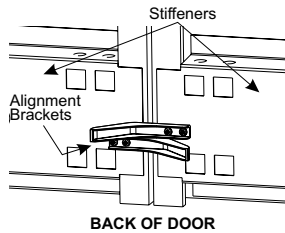

FIGURE 7

FIGURE 8

**Additional Instructions for bottomless track bracket application (4-panel doors only:** Bottomless track bracket requires the use of two alignment brackets at the bottom of each panel, attached to the stiffener (Figure 8).



#### Attaching alignment brackets:

**While doors are face down on flat surface,** position one alignment bracket with line indicator parallel with edge of door (Figure 9). Attach bracket to door using two self-drilling screws. Repeat on second

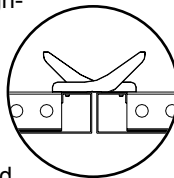
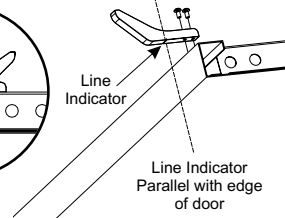

FIGURE 9



panel. **NOTE:** Brackets must have enough vertical clearance so that they will not touch when doors are in closed position. Make sure bottom of door panels are parallel with each other to assure correct vertical placement of brackets.

### 5. Adjust Doors to Opening

**To make tops of panels parallel to top track,** begin adjustment with doors in closed position. Loosen lower or upper track socket and slide in the desired direction (Figure 10). If necessary, adjust track sockets to obtain 1/8" clearance between the panels at the center when doors are in the closed position. **To make tops of panels even,** raise or lower panels by adjusting top of lower pivot (see Vertical Adjustment, Figure 5) to allow 1/8" between top track and top of panels. **TIGHTEN ROD CLAMP SCREW ON THREADED PIVOT.**

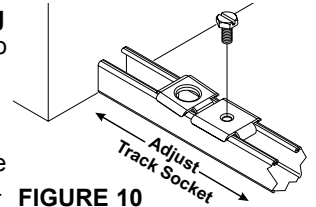

FIGURE 10

### 6. Install Plastic Bumpers

The round self-adhesive plastic bumpers go on the folded edge between the hinged panels and may be moved up, down, in or out until doors close flush (Figure 11). (Three discs per 2-panel unit.)

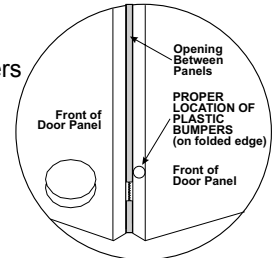

FIGURE 11

### 7. Track Bumpers

The track bumpers are self centering and are pre-installed in the upper and lower tracks. After all adjustments are made, close both doors with the track bumper in the center (Figure 12). The doors will automatically push the track bumper to the proper location.

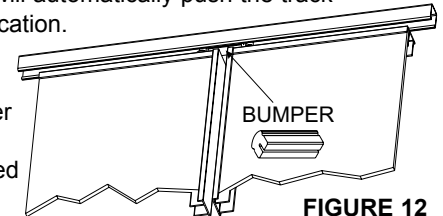

FIGURE 12

For improved operation, firmly set the top bumper in the track. Track bumpers may be trimmed to allow doors to close completely. **DO NOT OVERTRIM!** The bumpers must be long enough to create tension against the pivot spring rods.

### 9. Handle Locations / Installation

Most metal bifold doors have pre-drilled holes to accept the handles. If your door is not pre-drilled, please refer to Figure 13 for location of handles. Drill a 3/16" hole with a metal drill bit.

FIGURE 13

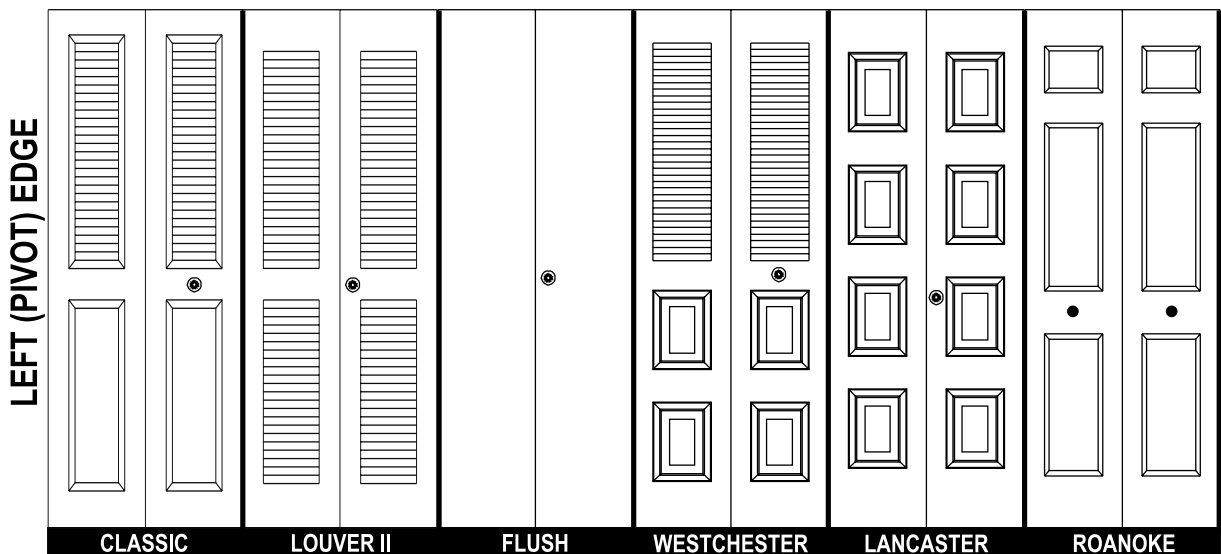

FIGURE 14

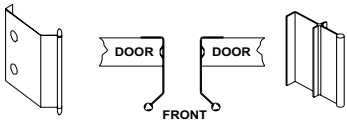

FIGURE 15

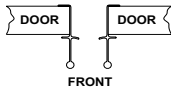
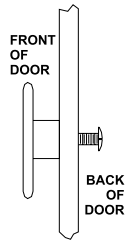

FIGURE 16



**Steel Bifolds:** Insert appropriate handle screw through drilled hole on back side of door panel. From front, engage the handle and screw (Figure 16). **DO NOT OVERTIGHTEN.**

**2700ST SERIES MIRRORS:** Position handle over two pre-drilled handle holes. Insert handles screws through handle and then through door edge. Thread cup washer and locknut on screw from back side of door (Fig. 14).

**2800AL/2900AL MIRRORS:** Remove facing strip from pre-installed double face tape. Position handle approximately 40" from bottom of door (or comfortable height) (Figure 15). Repeat with other handle, taking care to keep handles level.

**8. Changing Left Handed to Right Handed Door (Two-panel units)**

To change a left handed door to right handed door, place door face down. Move bottom threaded pivot rod from inside right hole to inside left hole. Move bottom left spring loaded guide rod from outside left hole to outside right hole.

Move top right spring loaded rod assembly from inside hole to outside hole. Move top left spring loaded rod assembly from outside hole to inside hole (Figure 17).

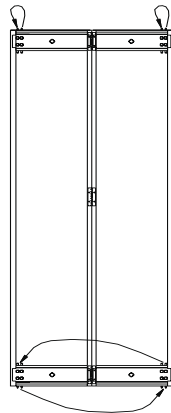

FIGURE 17

# SLIMTRIM

**10. Slimtrim™ Installation**

Slimtrim™ is a fascia molding designed and finished to blend with closet doors; perfect to cover odd size opening gaps up to 2-1/4".

Order Slimtrim to fit opening height. To assure neatly finished opening on all sides, select screws or nails of the proper length. Install Slimtrim™ flush with jamb corner. Use slotted holes to achieve proper adjustment. A short length of Slimtrim™ may also be used as a valance to conceal upper track (Figure 18).

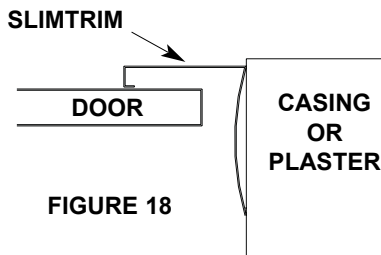

FIGURE 18

**SLIMFOLD PRODUCTS LIMITED LIFETIME WARRANTY**

Slimfold Products Division warrants to the purchaser that its products, when utilized for interior door use, will be free from defects in materials and workmanship for the life of the product.

Slimfold Products manufactured with galvanized steel are additionally warranted against rusting for a period of one (1) year from the date of purchase, provided the finish has not been cut or abraded through the metal. Galvanized steel should be used where air has a high salt content or in locations with high humidity.

This warranty is applicable only when the products covered by it have been installed in accordance with the recommended written installation instructions of Slimfold Products Division and with established building practices, have been accorded treatment which is considered good practice in the building industry regarding storage and maintenance, and have been subjected only to normal use. Because Slimfold Products Division cannot control the manner in which its products are handled after leaving its premises, this warranty does not apply to the finish or other damage occurring during shipment.

**There are no warranties, express or implied, which extend beyond the description on the face hereof, including the implied warranty of merchantability and the implied warranty of fitness for a particular purpose.**

Some states do not allow limitations on how long an implied warranty lasts, so the above limitation may not apply in some cases.

In the event the original consumer purchaser of any Slimfold product believes that the door or any parts thereof covered by this warranty is defective, a letter outlining the alleged defect should be sent postage prepaid to the following address:

**Slimfold Products Division  
PO Box 6416  
Dothan, AL 36302**

Any Slimfold Products part covered by this warranty which, upon inspection by an authorized representative of Slimfold Products Division, are found by said representative to be defective, will be repaired or replaced at the option of Slimfold Products Division. The purchase price of the part will be refunded and does not include labor, installation costs, finishing costs, or indirect or consequential damages of any nature. Some states do not allow the exclusion or limitation of incidental or consequential damages, so the above limitation or exclusion may not apply to you.

This warranty bestows certain legal rights, and you may also have other rights which vary from state to state.

**CARING FOR YOUR SLIMFOLD DOOR  
KEEP TRACK FREE OF DIRT AND PAINT!**

**Steel Bifolds**

Clean steel surface with a soft cloth using a mild detergent and water. Do not use harsh cleaners or abrasive.

**Mirrors**

- Clean mirror surface with clean, warm water or approved glass cleaner. Do not use any acid or alkali cleaners or cleaners with ammonia base. They will attack front surface, edges and backing of glass.
- Use a clean, soft cloth when cleaning to avoid scratching mirror surface.
- Never spray any cleaner directly on to the mirror. Apply to cloth first, then wipe mirror.
- Be sure to dry all edges thoroughly.

**Slimfold**  
**Prefinished Steel Bifold Doors**  
 A Product Division of  
**Dunbarton**

868 MURRAY ROAD | DOTHAN, ALABAMA 36303  
 334/794-0661 | 334/793-7022 (fax)  
**800-633-7553**  
 www.slimfold-doors.com  
 email: slimfold@dunbarton.com